

LAUNCHPORT

AP.5 Sleeve

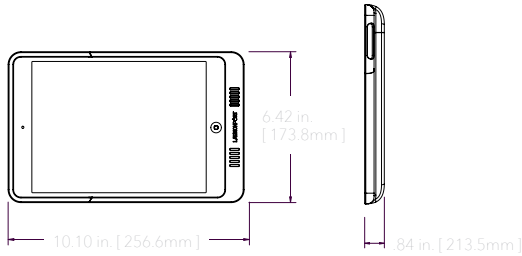

Dimensions

Weight: 0.6 lbs
 Height: 10.10"
 Width: 6.42"
 Depth: 0.84"
 Off Wall: 1.06"

What's in the Box

- Sleeve
- Quick Start Guide

SKU (Black) - #70300
SKU (White) - #70301

Power

- Input 15v 2 Amp
- Output 5v 2.4 Amp

AP.3 Sleeve / AP.4 Sleeve

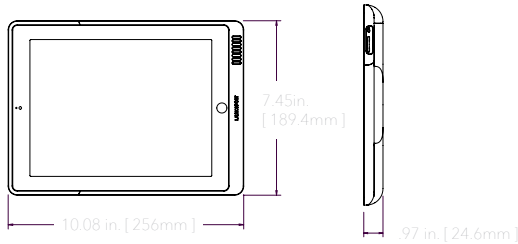

Dimensions

Weight: 0.7 lbs
 Height: 10.08"
 Width: 7.45"
 Depth: 0.97"
 Off Wall: 1.19"

What's in the Box

- Sleeve
- Quick Start Guide

AP.3
SKU (Black) - #70186
SKU (White) - #70187

AP.4
SKU (Black) - #70181
SKU (White) - #70182

Power

- Input 15v 2 Amp
- Output 5v 2.4 Amp

AM.1 Sleeve / AM.2 Sleeve

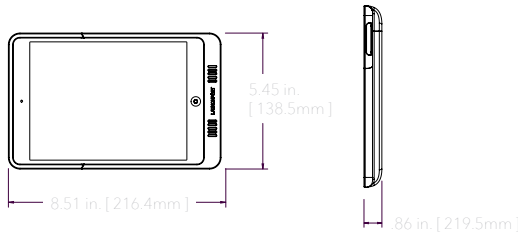

Dimensions

Weight: 0.44 lbs
 Height: 8.51"
 Width: 5.45"
 Depth: 0.86"
 Off Wall: 1.07"

What's in the Box

- Sleeve
- Quick Start Guide

AM.1
SKU (Black) - #70175
SKU (White) - #70176

AM.2
SKU (Black) - #70304
SKU (White) - #70305

Power

- Input 15v 2 Amp
- Output 5v 2.4 Amp

BaseStation

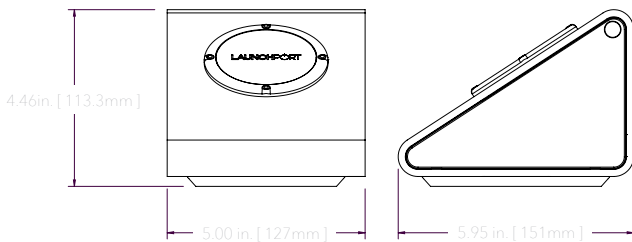

Dimensions

Weight: 3.6 lbs
 Height: 4.46"
 Width: 5.00"
 Depth: 5.95"

What's in the Box

- BaseStation
- Power Supply
- International Adaptor Kit
- Quick Start Guide

Power
 • Input 110-240v AC
 • Output 15v 2 Amp
SKU - #70141

WallStation

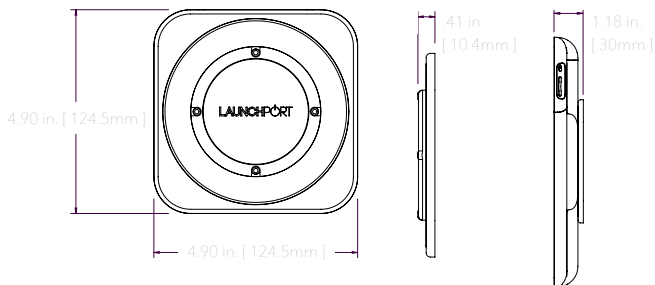

Dimensions

Weight: 0.61 lbs
 Height: 4.9"
 Width: 4.9"
 Total Depth: 1.42"
 Off Wall: 0.41"
 Depth Off Wall Including AP.3: 1.18"

What's in the Box

- WallStation assembly
- Hardware mounting kit
- Wall cut out template
- Power wall plate
- Power Supply
- International Adaptor Kit
- 6 feet of 18 AWG 2 conductor wire
- Quickstart Guide

Power
 • Input 110-240v AC
 • Output 15v 2 Amp
SKU (Black) - #70170
SKU (White) - #70142

CONTROL MOUNT

Control Mount Air

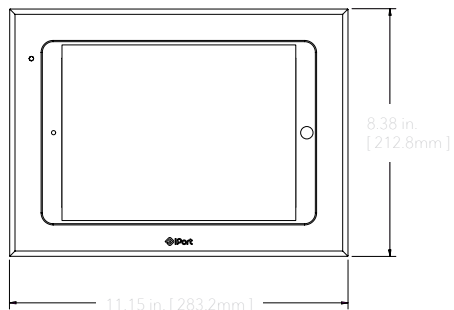

Dimensions

Weight: 3.59 lbs
Height: 8.38"
Width: 11.15"
Depth: 2.28"
Depth Off Wall: .2"

What's in the Box

- Retainer
- Fascia
- Quickstart Guide
- Hardware
- Wall Plate
- Power Supply
- Mounting Back Box
- USB Electronics Board
- Cut Out Template

Power

- Input 15v 2 Amp
- Output 5v 2.4 Amp

SKU (White) - #70095

Control Mount Mini

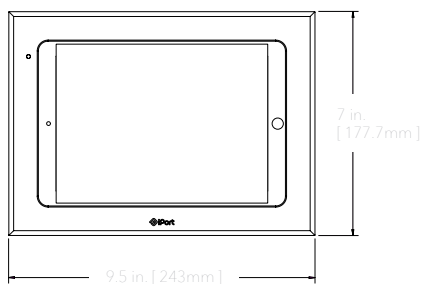

Dimensions

Weight: 1.75 lbs
Height: 7"
Width: 9.5"
Depth: 2"
Depth Off Wall: .18"

What's in the Box

- Retainer
- Fascia
- Quickstart Guide
- Hardware
- Wall Plate
- Power Supply
- Mounting Back Box
- USB Electronics Board
- Cut Out Template

Power

- Input 15v 2 Amp
- Output 5v 2.4 Amp

SKU (White) - #70094

CM-IW2000 V2

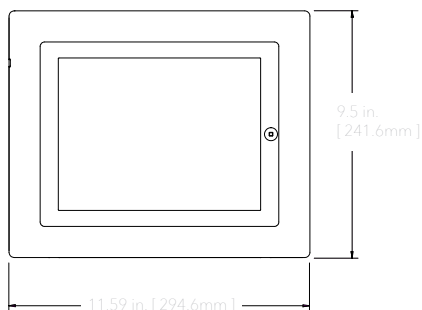

Dimensions

Weight: 4.55 lbs
Height: 9.5"
Width: 11.59"
Depth: 2.36"
Depth Off Wall: .36"

What's in the Box

- Retainer
- Fascia
- Quickstart Guide
- Hardware
- Wall Plate
- Power Supply
- Mounting Back Box
- USB Electronics Board
- Cut Out Template

Power

- Input 15v 2 Amp
- Output 5v 2.4 Amp

SKU (White) - #70093

CM-IW200

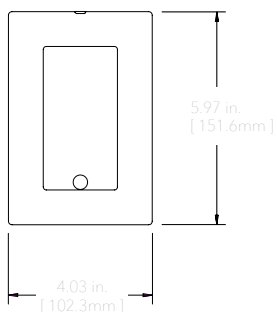

Dimensions

Weight: 1.07 lbs
Height: 5.97"
Width: 4.03"
Depth: 2.24"
Depth Off Wall: .21"

What's in the Box

- Retainer
- Fascia
- Quickstart Guide
- Hardware
- Wall Plate
- Power Supply
- Mounting Back Box
- 30-pin Electronics Board
- Cut Out Template

Power







- Input 15v 2 Amp
- Output 5v 2.4 Amp

SKU (White) - #70092





APPLE PRODUCT COMPATIBILITY

iPort Product	iPort SKU	iPad Air	iPad mini with Retina display	iPad mini	iPad 4th generation	iPad 3rd generation	iPad 2	iPad	iPod touch 4th generation
---------------	-----------	----------	-------------------------------	-----------	---------------------	---------------------	--------	------	---------------------------

LaunchPort

AP.5 Sleeve		70300, 70301	●						
AM.2 Sleeve		70304, 70305		●					
AM.1 Sleeve		70175, 70176			●				
AP.4 Sleeve		70181, 70182				●			
AP.3 Sleeve		70186, 70187					●	●	
AP.2 Sleeve		70140						●	

Control Mount

CM Air		70095	●						
CM Mini		70094		●	●				
CM-IW2000 V2		70093				●	●	●	●
CM-IW200		70092							●



San Clemente, CA 92672 USA

LaunchPort and iPort are trademarks of Dana Innovations, registered in the U.S. and other countries. Copyright 2014, all rights reserved.

iPad display images are simulations.

iPad is a trademark of Apple Inc., registered in the U.S. and other countries. "Made for iPad" means that an electronic accessory has been designed to connect specifically to iPad and has been certified by the developer to meet Apple performance standards. Apple is not responsible for the operation of this device or its compliance with safety and regulatory standards. Please note that the use of this accessory with iPad may affect wireless performance. Patent pending. Specifications subject to change.